



ITEM SYAM 800 DESIGNER BIO FIRE STAINLESS GRATE

MODEL DLBDG800

STYLE BRUSHED STAINLESS DOUBLE LAYERED BURNER WITH BURNER HOLDER

MOUNT FITTED



DESIGN

DIMENSIONS (LxWxH) 814x214x90mm

BURNER MATERIAL BRUSHED STAINLESS STEEL

WEIGHT 20.0 kg

STRUCTURE WELDED / FULLY ASSEMBLED

DETAIL

FUEL BIOETHANOL

FUEL CONSUMPTION AROUND 0.8 L/h

HEATING UP TO 320m³

IGNITION MANUAL

BURNER 1 x DOUBLE LAYERED

FUEL CAPACITY 6.3 L

FEATURES

FLUELESS - NO CHIMNEY REQUIRED, 100% HEAT EFFICIENCY / LOWER BUILDING COSTS

IGNITION & FLAME EXTINGUISHING - FLAME KILLER PROVIDED

BURNER HOLDER - FOR ADDITIONAL SAFETY AGAINST LEAKAGE

STAINLESS STEEL GRATE - IMPROVED CORROSION RESISTANCE WHERE NEEDED MOST

ENVIRONMENTALLY FRIENDLY - SMOKELESS, ODOURLESS AND VISUALLY APPEALING

NOTE-

SYAM PEBBLES OR FIREGLASS CAN BE PLACED AROUND BURNER FOR AESTHETICS
 AS FIRE CONSUMES OXYGEN, AREA SHOULD BE VENTILATED FOR THE FRE FLOW OF AIR
 BIOETHANOL IS HIGHLY FLAMABLE AND MUST BE STORED SAFELY AWAY AND OUT OF REACH FROM CHILDREN
 IF SWOLOWED MEDICAL ATTENTION SHOULD BE SOUGHT

PACKAGING

1 BOX 23.0 kg (LxWxH) - 865x270x170mm M³ - 0.04

REV 2.1



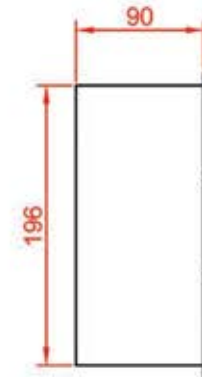
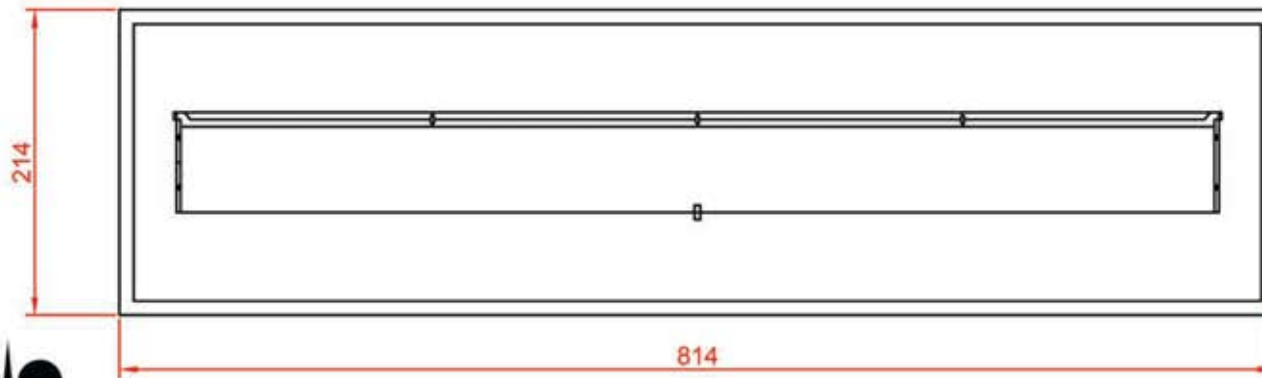
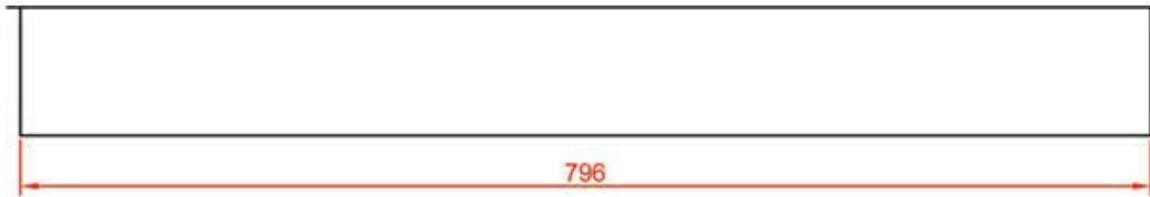
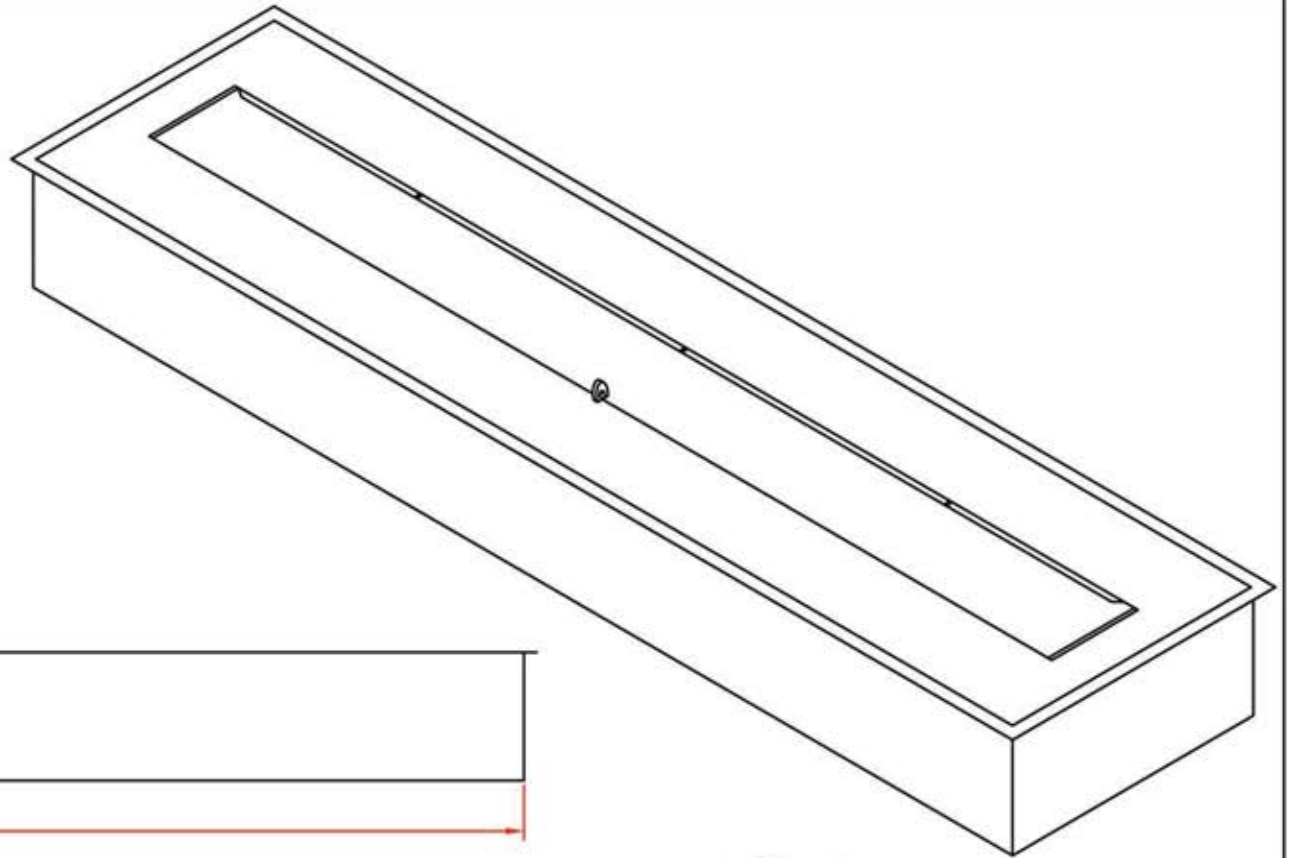
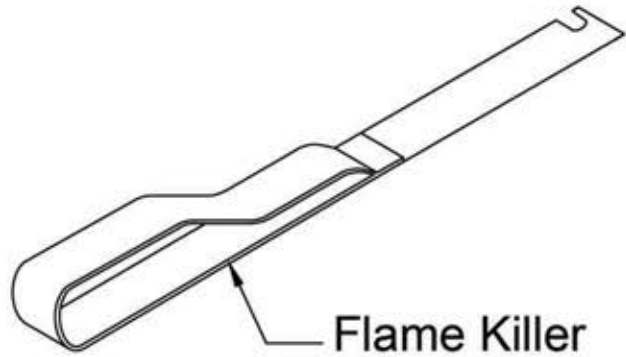

STAINLESS STEEL

DESIGNER BIO GRATE BUILT IN PLAN

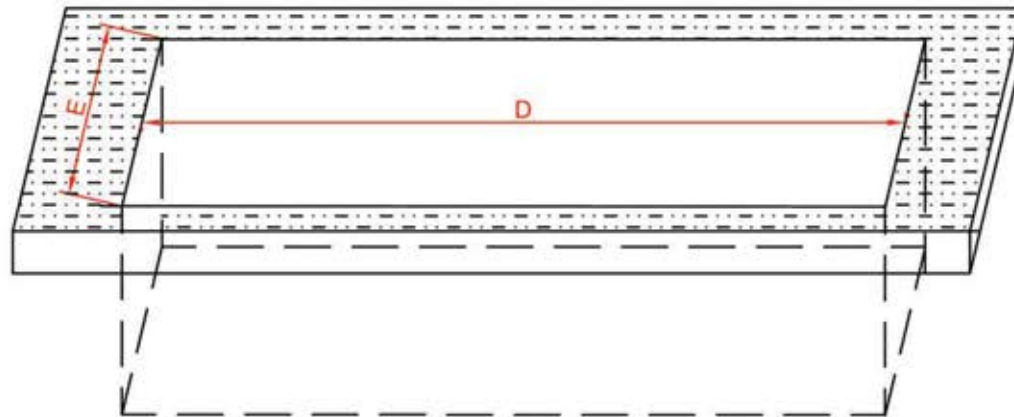
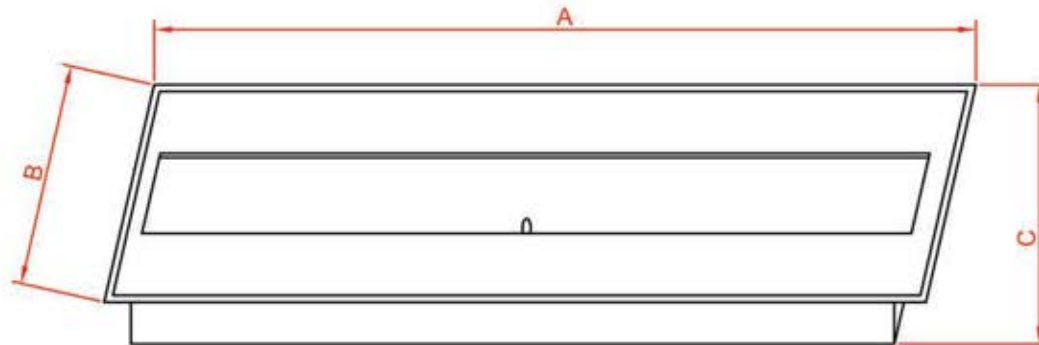

GRATE BUILT IN PLAN				
GRATE SIZE	600	800	1000	1500
A	614	814	1114	1603
B	214	214	214	219
C	90	90	90	114
CUT-OUT SIZE				
D	600	800	1100	1585
E	200	200	200	200
MIN. DEPTH	100	100	100	120

- ROOM TO HAVE ADEQUATE VENTILATION
- NEVER REFUEL WHILE FLAME IS LIT
- ONLY REFUEL WHEN GRATE IS COOL.

REV 2.1